

# Couplings & Trailer Support

Couplings for Braked & Unbraked Trailers • Jockey wheels • Propstands

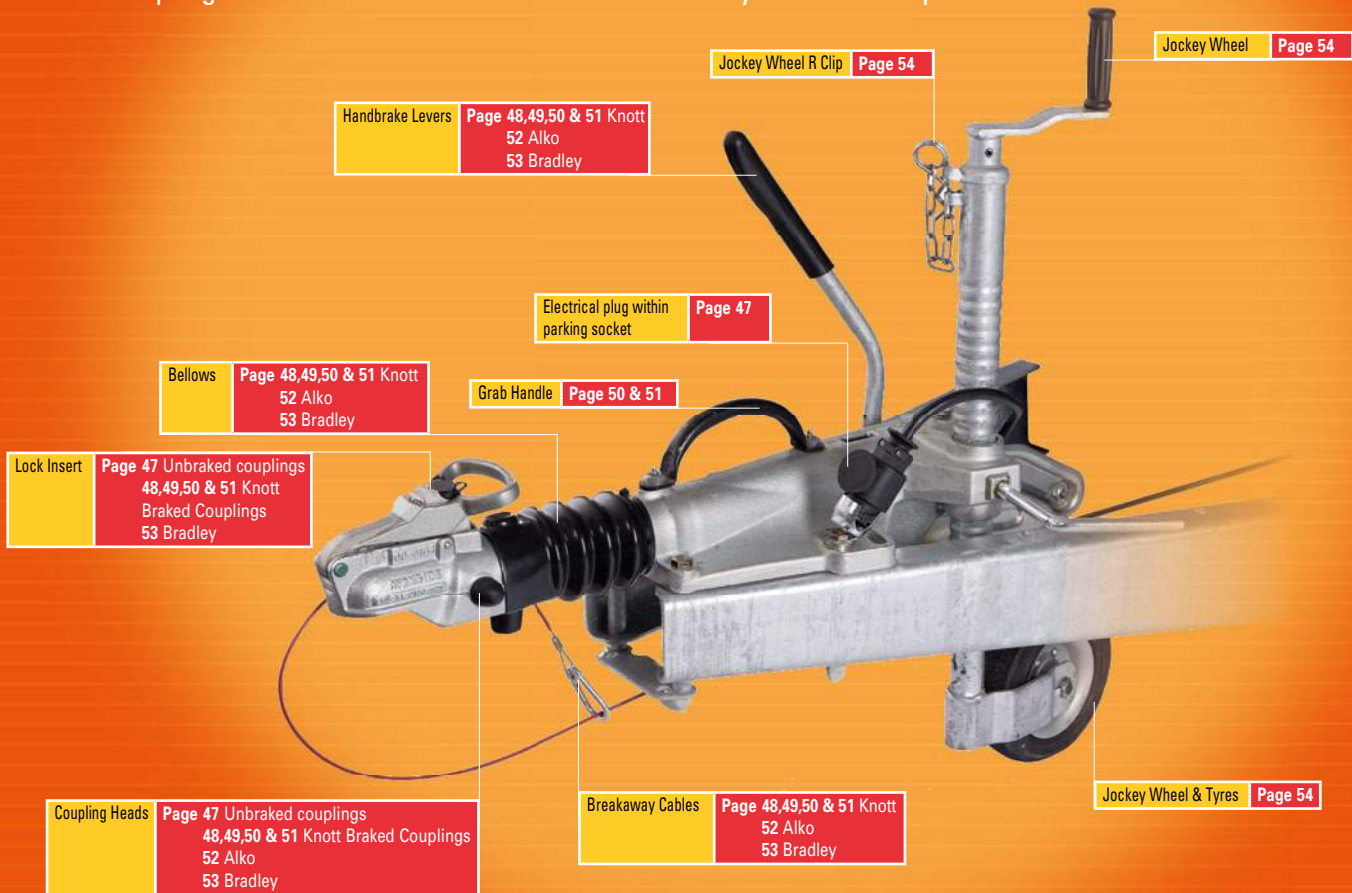

## Contents

	Page
Unbraked Couplings & Spares	47
KF13 & KF13E Couplings & Spares	48
KF20, KFG20 & KRV20 Couplings & Spares	49
KFG27 Coupling & Spares	50
KFG35 Coupling & Spares	51
Al-Ko Coupling & Spares	52
Bradley Couplings & Spares	53
Propstands & Jockey Wheels	54
Bolt On Propstands	55

P00280	<b>Unbraked Coupling Assembly KZE 7.5 110 – 120MM centres.</b> Used on the Q#e and unbraked Eurolight range.
P00355LDB	<b>Coupling/Drawbar.</b> Swan neck style drawbar and coupling head. Used on the P5 Range.
P00355DB	<b>Coupling/Drawbar.</b> Swan neck style drawbar and coupling head used on the BV64e & P6e Range.
P00355DB2	<b>Coupling/Drawbar.</b> Swan neck style drawbar and coupling head used on the P7e Range.
P00355DB3	<b>Coupling/Drawbar.</b> Swan neck style drawbar and coupling head used on the P8e
P00355DBQ	<b>Coupling/Drawbar.</b> Used on the Q5e Road.
C24431	<b>Straight Drawbar.</b> Q5e Off Road. Coupling head not included.
1 P00355	<b>Coupling Head.</b> 750kg 50mm ball, pressed steel head. Used on all unbraked trailers.
2 P00270	<b>Swivel Hitch.</b> Used on the Q5e Off Road. Not approved for on-road use.
3 P0150	<b>Coupling Head.</b> 750kg 50mm ball, cast iron coupling head. Used on older P6e drawbars.
4 P00354*	<b>Slider lock.</b> Fits within the sliding bolt aperture on the P00355 head to prevent operation of the handle, can also be used when coupled to car.
P00355SC	<b>Secondary coupling cable.</b> Used with P00355 unbraked coupling head.
P00355SK	<b>Drawbar Skid.</b> Used on all unbraked trailers.
5 P00355PP	<b>Electrical Plug Parking Socket.</b> Can be fitted with braked & unbraked couplings.
6 WT5100-00020	<b>Coupling Raiser.</b> 20mm used on the Q#e range.



P6e with tailboard and 145/70R13 tyres.



## KF13 & KF13E



EYE MAY DIFFER FROM THE PHOTOGRAPH

- 1 P00317-120 KF13 Coupling Unit.** Pressed Steel Body 750 -1400kg GVW. 120mm bolt spacings, hydraulically damped overrun coupling unit, incorporating energy store handbrake for use with autoreverse brakes and 50mm ball head. Used on the BV\*4, BV\*5 – single axle, GD\*4 & GD\*5 – single axle ranges & P\*G.
- P00307 KF13E Coupling Unit.** 1400kg GVW, 120mm bolt spacings, fitted with pressed steel head. Used on the EL Eurolight, P#b & Q#b ranges.
- 2 P00301 Coupling Head.** Replacement low profile 50mm coupling head for the KF13 coupling. Includes the lock and two keys. Requires P00939 packing shim.
- P003075 Pressed Steel Coupling Head KF13E.** To fit 45mm drawtube. Lockable with a padded grip. For the P00307 Coupling. Used on the Eurolight range. Requires P00939 packing shim.
- P00939 Packing Shim.** Fits under the coupling heads P00301 & P003075.
- 3 P00302 Lock insert.** Replacement lock for the Avonride coupling head. KF13 coupling.
- 4 P00303 Cover Cap.** Protects the Avonride coupling head lock from ingress of dust and water. KF13 coupling.
- 5 P00318C 30mm Eye Kit.** Includes all mounting hardware.
- P00333 40mm Eye Kit.** Includes all mounting hardware.
- 6 P00369 Bellows.** Replacement protective bellows.
- 7 P00937 Damper.** Replacement hydraulic damper for KF13, KF13E.
- P00936 Damper Bracket.** Holds one end of the damper rod within the body of the coupling.
- 8 P00938 Drawtube.** Includes stop ring.
- 9 P00931 Powered Handbrake Upgrade Kit.** Complete with oil-damped spring pack, handbrake lever and all mounting hardware etc.
- P00929 Oil Damped Spring Pack.**
- P00928 Hand Brake Lever Assembly.**
- 10 P00940 Overrun Lever.** Fitted to the rear of the coupling unit, this lever creates the pull on the brake rod.
- 11 P00892 Shoulder Bolt.** Fits through the centre of the overrun lever to secure the handbrake lever in place.

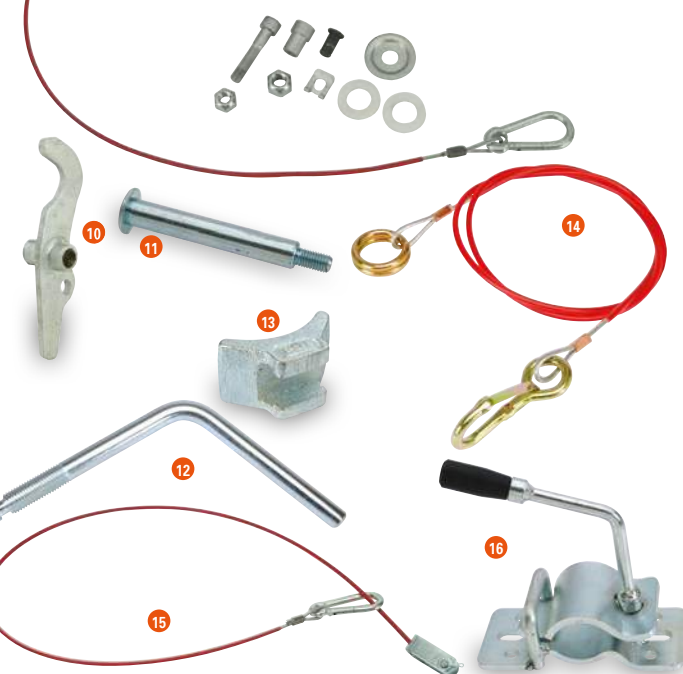

- 12 P00363 Clamp handle.** Short jockey wheel clamp handle.
- 13 P00399 Retainer pad.** Fits within the recess in the overrun unit to securely clamp the jockey wheel.
- 14 P00387 Breakaway cable spring ring type.** It is recommended that you carry a spare breakaway cable whenever you tow.
- 15 P00899 Breakaway cable clevis type.** For more recent knott couplings having this type of cable fitted originally.
- 16 P0235 Jockey Wheel Clamp.** Used on the Q#b, P#b, EL101, EL142, EX202 & EL141. Compatible with the P00307 & P00308 couplings.

### KF20, KFG20 & KRV20

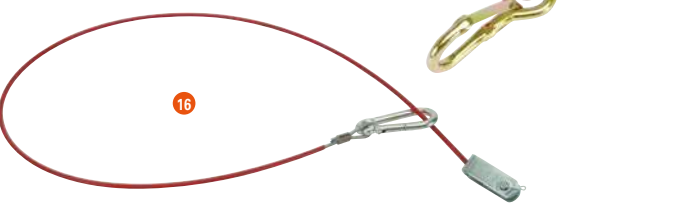
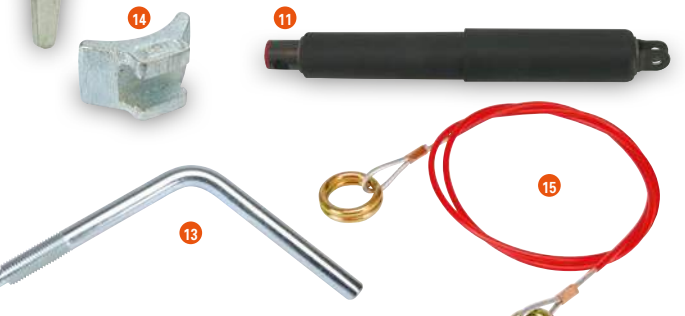
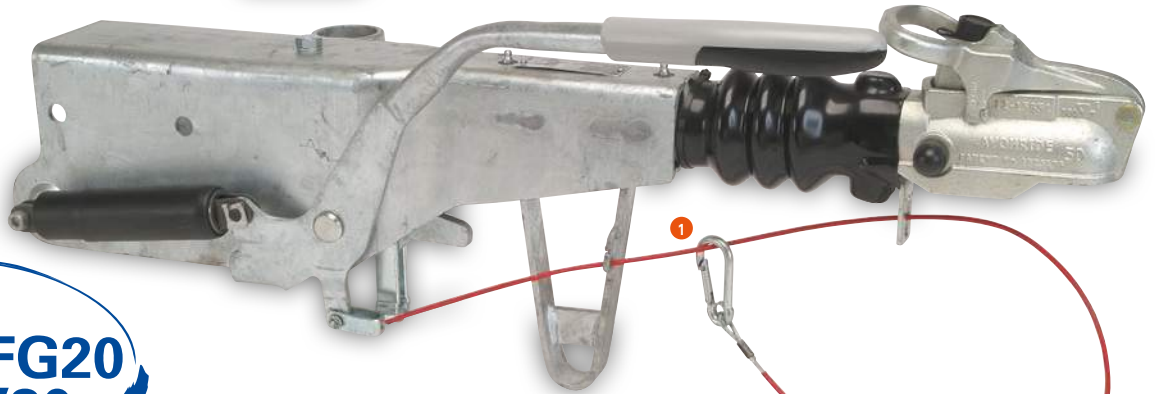

EYE MAY DIFFER FROM THE PHOTOGRAPH

- P00308** Coupling Unit KF20. 120mm centres. Lockable pressed steel head. High rear bracket. Used on the Eurolight range EX202-2515, 3015 & 3615.
- P00320** Coupling Unit KRV20 (Pressed Steel Body) For 100Mm Square Tube Drawbars. 1100-2000Kg GVW Hydraulically damped overrun coupling unit, incorporating energy store handbrake for use with autoreverse brakes and 50mm ball hitch. Used on the HB401 & HB403.
- P00324** Coupling Unit KFG20 (KPD20POD). With pressed steel head. Used on the CT115 & CT136.
- P00330** Coupling Unit KFG20. Weight range 1100 - 1200kg. 50mm lockable low profile coupling head. Used on the GH64.
- P00301** Coupling Head. Replacement lockable low profile head for the KRV20 & P00330 KFG20 couplings.
- P003085** Coupling Head. Replacement head for the P00324 KFG20 coupling. P00939 packing shim also required.
- P00302** Lock insert. Replacement lock for the Avonride coupling head. Used on the Avonride head fitted to the KFG20 & KRV20 coupling units.
- P00303** Cover Cap. Protects the Avonride coupling head lock from ingress of dust and water. Used on the Avonride head fitted to the KFG20 & KRV20 coupling units.
- P00333** 40mm Eye Kit. Includes all mounting hardware. For the KFG20 coupling.
- P00369** Bellows. Replacement protective bellows for the KF20 & KRV20 coupling.
- P00417** Bellows. Replacement protective bellows for the P00324 KFG20 coupling.
- P00373** Damper. Replacement hydraulic damper for the KF20, KRV20 & KFG20 couplings.
- P00938** Drawtube. For the KF20, KFG20 & KRV20 couplings.
- P00413** Overrun Lever. For the KFG20 couplings.
- P00940** Overrun Lever. For the KF20 & KRV20 couplings.
- P00868** Spring Pack. Oil damped unit for the KFG20 & KRV20 couplings.
- P00929** Spring Pack. Oil damped unit for the KF20 coupling.
- P00869** Handbrake Lever. For the KFG20 & KRV20 couplings.
- P00928** Handbrake Lever. For the KF20 coupling.
- P00363** Clamp Handle. Jockey clamp handle.
- P00399** Retainer Pad. Fits within the recess in the overrun unit to securely clamp the jockey wheel.
- P00387** Breakaway Cable Spring Ring Type. It is recommended that you carry a spare breakaway cable whenever you tow.
- P00899** Breakaway Cable Clevis Type. For more recent Knott couplings having this type of cable fitted originally.



## KFG27



**1 P00335 KFG27 Coupling Unit (Cast Body).** 1400-2700kg GVW Hydraulically damped overrun coupling unit, incorporating energy store handbrake for use with autoreverse brakes and 50mm ball hitch. Used on the BV4TA, BV5G, CT136HD, GD84TA, GD5, GD6, GH94, GX4, GX5, HB505, HB510, LM5, TA5G & TT85G.

**P00335-120HB KFG27 Coupling Unit 120mm bolt spacing.** Used on the GD4HD, HB506, HB511, LT range, TA5G 12' x 4' & TT2515.

**2 P00301 Coupling Head.** Replacement lockable low-profile head for KF/KFG overrun units with a 50mm drawtube.

**3 P00302 Lock Insert.** Replacement lock for the Avonride coupling head.

**4 P00303 Cover Cap.** Protects the Avonride coupling head lock from ingress of dust and water.

**5 P00404 30mm Eye.** Eye kit includes all mounting hardware to fit KFG27 overrun unit.

**6 P00339 40mm Eye.** Eye kit includes all mounting hardware to fit KFG27 overrun unit.

**P00420 50.8mm Eye Kit.** Eye kit includes all mounting hardware to fit KFG27 overrun unit.

**7 P00376A Nato Eye.** Eye kit includes all mounting hardware to fit KFG27 overrun unit.

**8 P00369 Bellows.** Replacement protective bellows for drawtube of KF27 (Pressed steel body).

**9 P00417 Bellows.** Replacement protective bellows for drawtube of KFG27 overrun unit (Cast body).

**10 P00374 Damper.** Replacement hydraulic damper for KFG27.

**P00878 Damper Support Bracket.** Fits within body of coupling.

**11 P00881 Grab Handle.**

**P00882 Grease nipple adaptor.** Bolt that is fitted through handle.

**12 P00408 Drawtube.** 50 x 10 DIN2391.

**13 P00869 Hand Brake Assembly KFG Low Type.**

**14 P00868 Oil Damped Spring Pack Knott.** Oil - damped unit only, as fitted to later or upgraded units.

**15 P00867 Spring Pack Mount Plate.**

**16 P00413 Overrun Lever.** Fitted to the rear of the coupling unit, this lever creates the pull on the brake rod.

**17 P00892 Shoulder Bolt.** Fits through the centre of the overrun lever to secure the handbrake lever in place.

**18 P00363 Clamp Handle.** Short jockey clamp handle for Knott couplings.

**19 P00399 Retainer pad.** Fits within the recess in the overrun unit to securely clamp the jockey wheel.

**20 P00387 Breakaway Cable Spring Ring Type.** It is recommended that you carry a spare breakaway cable whenever you tow.

**21 P00899 Breakaway Cable Clevis Type.** For more recent Knott couplings having this type of cable fitted originally.



**22 P00915 Manual Reverse Kit.** While the basic reversing function remains automatic, this kit allows easier reversing up steep hills or on poor surfaces, where traction can sometimes be a problem. Please note Can only be fitted to the KFG27 coupling manufactured from late 2005 that has slot fitted as standard.

## KFG35

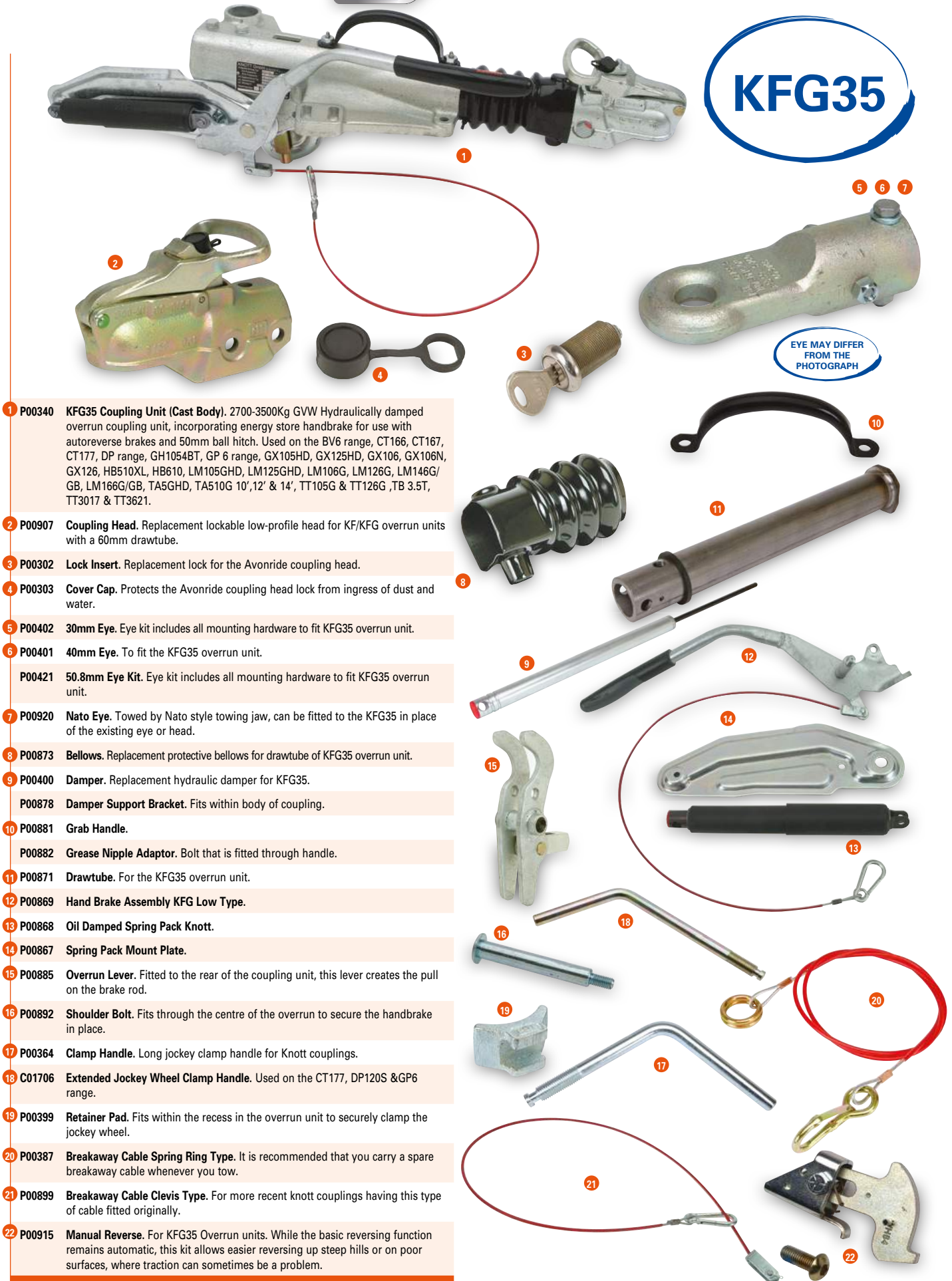

EYE MAY DIFFER FROM THE PHOTOGRAPH

- 1 P00340 KFG35 Coupling Unit (Cast Body).** 2700-3500Kg GVW Hydraulically damped overrun coupling unit, incorporating energy store handbrake for use with autoreverse brakes and 50mm ball hitch. Used on the BV6 range, CT166, CT167, CT177, DP range, GH1054BT, GP 6 range, GX105HD, GX125HD, GX106, GX106N, GX126, HB510XL, HB610, LM105GHD, LM125GHD, LM106G, LM126G, LM146G/GB, LM166G/GB, TA5GHD, TA510G 10', 12' & 14', TT105G & TT126G, TB 3.5T, TT3017 & TT3621.
- 2 P00907 Coupling Head.** Replacement lockable low-profile head for KF/KFG overrun units with a 60mm drawtube.
- 3 P00302 Lock Insert.** Replacement lock for the Avonride coupling head.
- 4 P00303 Cover Cap.** Protects the Avonride coupling head lock from ingress of dust and water.
- 5 P00402 30mm Eye.** Eye kit includes all mounting hardware to fit KFG35 overrun unit.
- 6 P00401 40mm Eye.** To fit the KFG35 overrun unit.  
**P00421 50.8mm Eye Kit.** Eye kit includes all mounting hardware to fit KFG35 overrun unit.
- 7 P00920 Nato Eye.** Towed by Nato style towing jaw, can be fitted to the KFG35 in place of the existing eye or head.
- 8 P00873 Bellows.** Replacement protective bellows for drawtube of KFG35 overrun unit.
- 9 P00400 Damper.** Replacement hydraulic damper for KFG35.  
**P00878 Damper Support Bracket.** Fits within body of coupling.
- 10 P00881 Grab Handle.**  
**P00882 Grease Nipple Adaptor.** Bolt that is fitted through handle.
- 11 P00871 Drawtube.** For the KFG35 overrun unit.
- 12 P00869 Hand Brake Assembly KFG Low Type.**
- 13 P00868 Oil Damped Spring Pack Knott.**
- 14 P00867 Spring Pack Mount Plate.**
- 15 P00885 Overrun Lever.** Fitted to the rear of the coupling unit, this lever creates the pull on the brake rod.
- 16 P00892 Shoulder Bolt.** Fits through the centre of the overrun to secure the handbrake in place.
- 17 P00364 Clamp Handle.** Long jockey clamp handle for Knott couplings.
- 18 C01706 Extended Jockey Wheel Clamp Handle.** Used on the CT177, DP120S & GP6 range.
- 19 P00399 Retainer Pad.** Fits within the recess in the overrun unit to securely clamp the jockey wheel.
- 20 P00387 Breakaway Cable Spring Ring Type.** It is recommended that you carry a spare breakaway cable whenever you tow.
- 21 P00899 Breakaway Cable Clevis Type.** For more recent knott couplings having this type of cable fitted originally.
- 22 P00915 Manual Reverse.** For KFG35 Overrun units. While the basic reversing function remains automatic, this kit allows easier reversing up steep hills or on poor surfaces, where traction can sometimes be a problem.



251S

Used on the  
HB505 up to  
September 1992

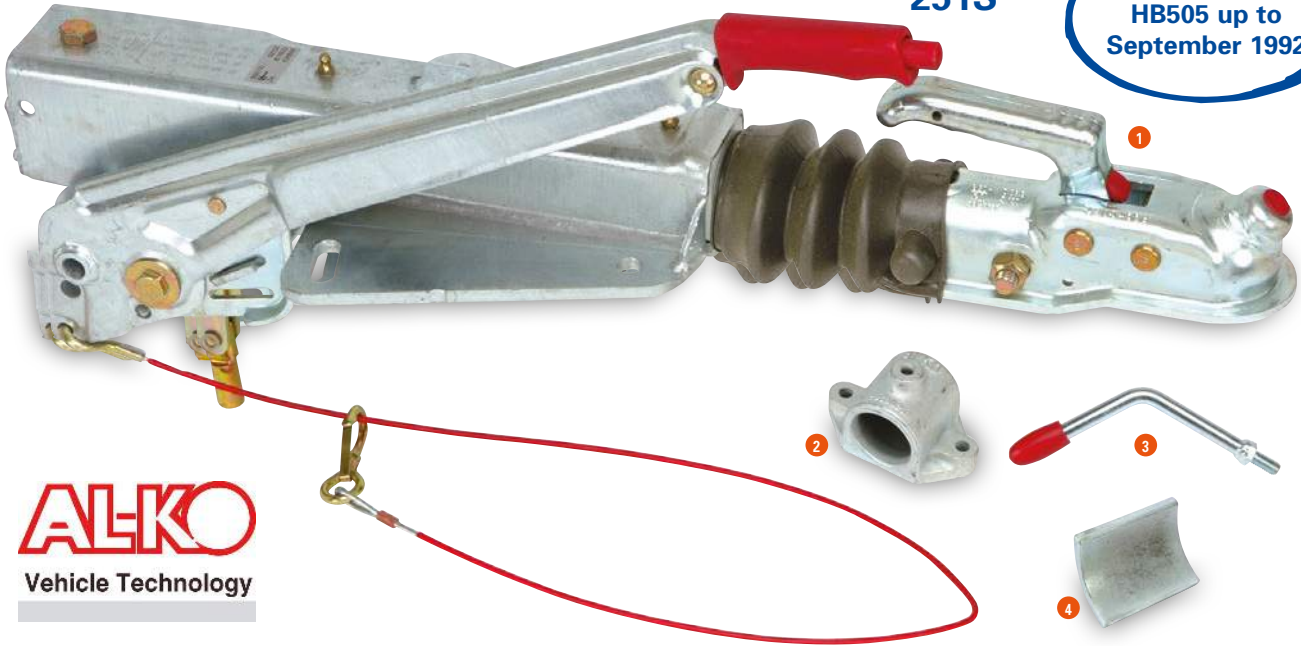

**ALKO**  
Vehicle Technology

- 1 **P0515 251S Coupling unit.** 1500-2600Kg GVW Hydraulically damped overrun coupling unit, incorporating gas sprung handbrake for use with autoreverse brakes and 50mm ball.
- 2 **P0549 Jockey Bracket.** Type 295-191 this is used on the 251s overrun unit.
- 3 **P0549H Clamp handle.** For the 295-191 Bracket.
- 4 **P0549P Pad.** Fits within the recess in the 295-191 Bracket to clamp against the jockey wheel tube.
- 5 **P0542 Damper.** Old Type. (325mm Centres).
- 6 **P0542A Damper.** New Type. (505mm Centres).
- 7 **P0528 Head.** Replacement coupling head for 251's overrun unit.
- 8 **P0551 Bellows.** For the 251s overrun unit.
- 9 **P0545 Brake lever.** For the 251s overrun unit.
- 10 **P0548 Outer clamp.** Outer part of Jockey wheel clamp on 251S overrun unit.
- 11 **P00387 Breakaway cable.** It is recommended that you carry a spare breakaway cable whenever you tow.



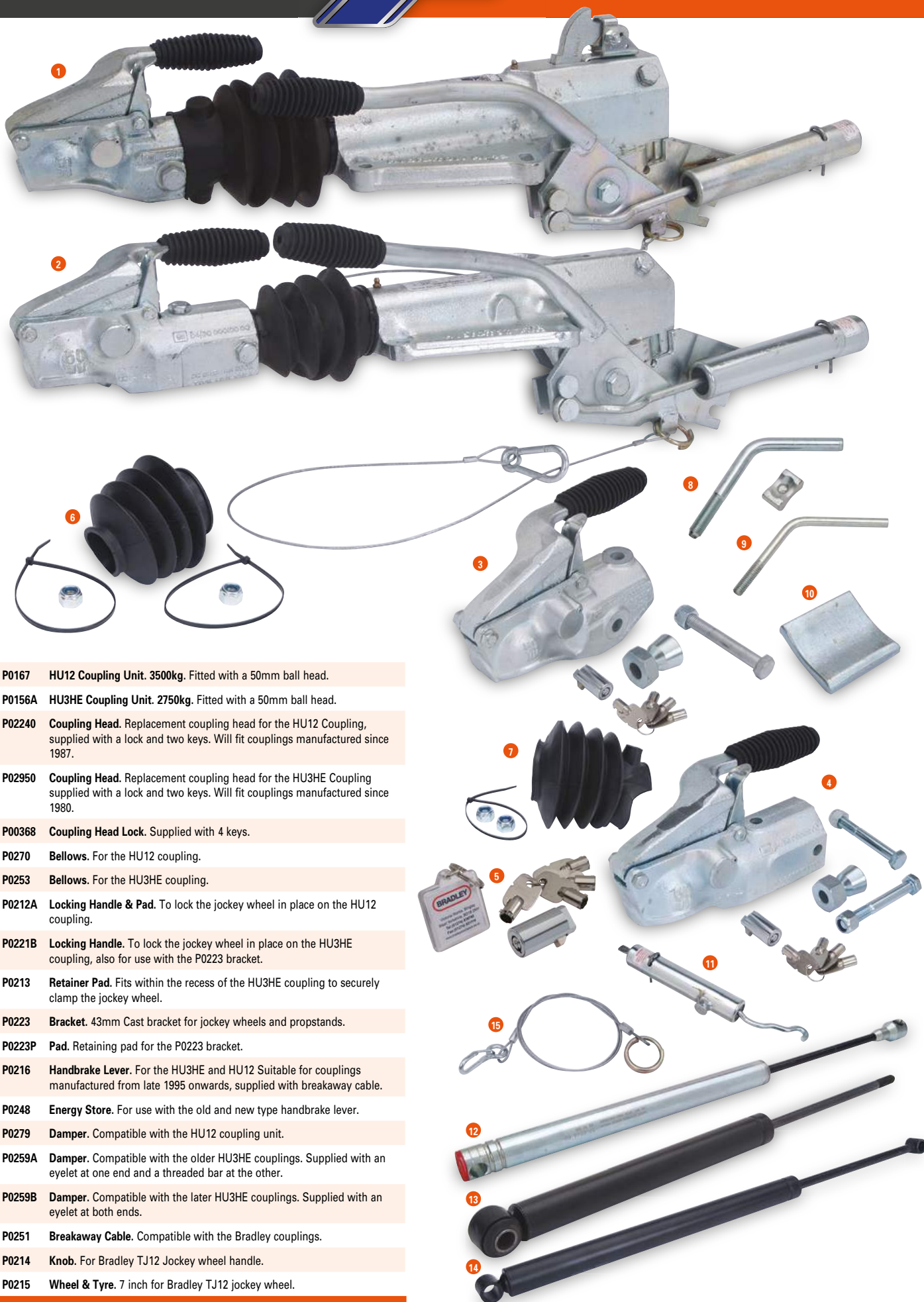

- 1 **P0167 HU12 Coupling Unit. 3500kg.** Fitted with a 50mm ball head.
- 2 **P0156A HU3HE Coupling Unit. 2750kg.** Fitted with a 50mm ball head.
- 3 **P02240 Coupling Head.** Replacement coupling head for the HU12 Coupling, supplied with a lock and two keys. Will fit couplings manufactured since 1987.
- 4 **P02950 Coupling Head.** Replacement coupling head for the HU3HE Coupling supplied with a lock and two keys. Will fit couplings manufactured since 1980.
- 5 **P00368 Coupling Head Lock.** Supplied with 4 keys.
- 6 **P0270 Bellows.** For the HU12 coupling.
- 7 **P0253 Bellows.** For the HU3HE coupling.
- 8 **P0212A Locking Handle & Pad.** To lock the jockey wheel in place on the HU12 coupling.
- 9 **P0221B Locking Handle.** To lock the jockey wheel in place on the HU3HE coupling, also for use with the P0223 bracket.
- 10 **P0213 Retainer Pad.** Fits within the recess of the HU3HE coupling to securely clamp the jockey wheel.
- P0223 Bracket.** 43mm Cast bracket for jockey wheels and propstands.
- P0223P Pad.** Retaining pad for the P0223 bracket.
- 11 **P0216 Handbrake Lever.** For the HU3HE and HU12 Suitable for couplings manufactured from late 1995 onwards, supplied with breakaway cable.
- 12 **P0248 Energy Store.** For use with the old and new type handbrake lever.
- 13 **P0279 Damper.** Compatible with the HU12 coupling unit.
- 14 **P0259A Damper.** Compatible with the older HU3HE couplings. Supplied with an eyelet at one end and a threaded bar at the other.
- 15 **P0259B Damper.** Compatible with the later HU3HE couplings. Supplied with an eyelet at both ends.
- 16 **P0251 Breakaway Cable.** Compatible with the Bradley couplings.
- 17 **P0214 Knob.** For Bradley TJ12 Jockey wheel handle.
- 18 **P0215 Wheel & Tyre.** 7 inch for Bradley TJ12 jockey wheel.





- 1 P0475 Jockey wheel 48mm.** Heavy duty ribbed shaft design and heavy duty tyre. Suits the Bradley HU12, Knott KFG35 couplings or the P0209 clamp.
- 2 P0475H Jockey wheel 48mm.** Heavy duty version with extended slimline handle for extra clearance against winch brackets. Fitted with the P04751 tyre.
- 3 P0474 Jockey wheel 48mm.** Medium duty smooth stem design, suits the Knott KF13, KF13E, KF20, KFG20, KRV20 KFG27 & Alko P0515 couplings.
- 4 P0476 Jockey wheel 42mm.** Standard duty smooth stem design, suits the Bradley HU3H & HU3HE couplings.
- 5 P0567 Jockey Wheel 35mm.** Suits the BV64e, P5, P6e, P7e, P8e, Q range and the unbraked Eurolight.



- 6 KX0221 Propstand kit.** Pair of propstands for the GD range.
- 7 KX0222 Propstand kit.** Pair of propstands for the Box Van and Horsebox range.
- KX0224 Propstand kit.** Pair of propstands for the BV4 & BV5 range.
- KX0225 Propstand kit.** Pair of propstands for the P#e, P#b & Q ranges.
- KX0233 Propstand kit.** Pair of propstands for the HB403, HB506 & HB511.

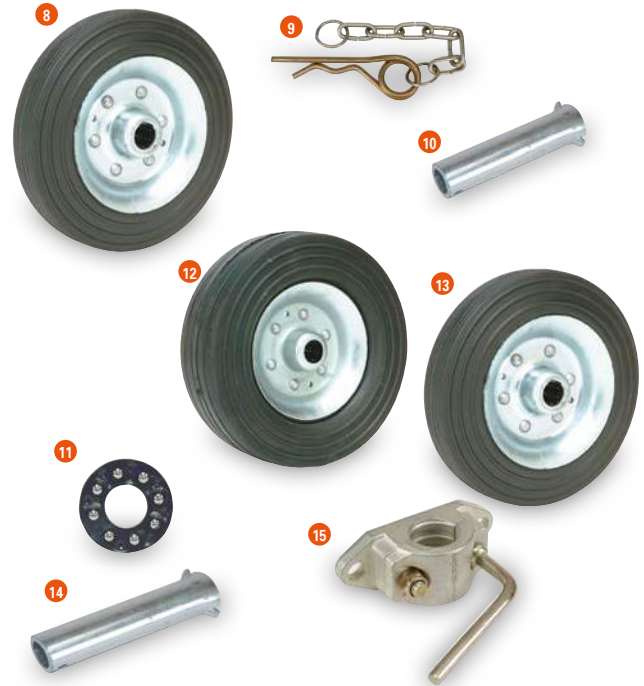

- 8 P04741 Wheel.** Wheel & tyre 52mm x 200mm diameter. Suits the P0474, P0476 & P0567 Jockey wheels.
- 9 P04743 R clip.** Includes chain, as fitted to P0474, P0475 & P0476.
- 10 P04744 Axle tube.** Fits items 3 & 4.
- 11 P04745 Thrust bearing unit.** Fits between inner and outer stem of P0475, P0475H, P0474 & P0476 Jockey wheels.
- P04746 Thrust Bearing Washer.** To be fitted with the P04745 thrust bearing.
- 12 P04751 Wheel.** Wheel and tyre 75mm wide x 235mm diameter. Suits the older P0475 Jockey wheels and P0475H Jockey wheels.
- 13 P04752 Wheel.** Wheel and tyre 60mm wide x 210mm diameter. Suits the current P0475 Jockey wheel.
- 14 P04754 Jockey wheel axle.** For the wide tyre fitted to heavy duty ribbed jockey wheels.
- 15 P0209 Clamp bracket.** Complete clamp bracket for all our ribbed heavy duty jockey wheels & propstands.
- P0209SP Split pin.** Fitted through top of heavy duty prop stand.
- P0209H Handle.** For heavy duty prop stand clamp.
- P0209N2 Nut M16.** (Clamp nut used in the P0209 bracket).
- P0221 Propstand bracket.** Mounting bracket for 35mm propstand or jockey wheel, requires pad and handle to complete.
- P0221P Retainer pad.** Fits within the recess of the P0221 bracket.
- P0221H Clamp handle.** M12 for metric propstand clamps.
- P0223 Jockey bracket.** P200 bracket for fitting 42mm diameter jockey wheels or propstand tubes.
- P0223P Pad.** For bracket P0223.
- P0221B Clamp handle.** 1/2" For the P0223 Bracket.



- 16 AS5875 Propstand Leg.** Used on the P5, P6, P7, P8 & Q ranges. 460mm.
- AS5874 Propstand Leg.** Used on the BV4 & 5, HB & GD ranges. 560mm.
- P0197 Propstand leg.** Serrated shaft, used on the BV6 range with 12" wheels. 590mm.
- P0196 Propstand leg.** Serrated shaft, used on the BV6 range with 16" wheels. 720mm.



- 1 KX0227 Propstand Kit.** Pair of propstands and fittings. Compatible with the Beavertail, Flatbed and old tipper range.
- KX0220 Propstand kit.** Pair of propstands and fittings for current LT/LM85 trailer range.
- KX3185 Propstand Kit.** Pair of propstands, spigots and backing plates for the Eurolight range.
- 2 KX6316 Propstand Kit.** Pair of propstands for the current TT Tipper range.
- P1114 Propstand.** Individual propstand. Compatible with the Beavertail, Eurolight & Flatbed range.
- P11145 Propstand.** Individual propstand leg for the TT range.
- 3 P1115/P Pin Assembly.** Compatible with the P1114 & P11145 propstands.
- 4 P11170G Bolt on Spigot.** Compatible the Beavertail, Flatbed and old Tipper range.



• LM146 with headboard, dropsides, mesh sides, ramp and prop stands.